

Voyager Keyboard Connector

Top
↑

- KC2
- KC1
- KR1
- KR3
- KC0
- KR6
- KR5
- KR4
- KR7
- KR2
- KC3
- KC4
- KR0

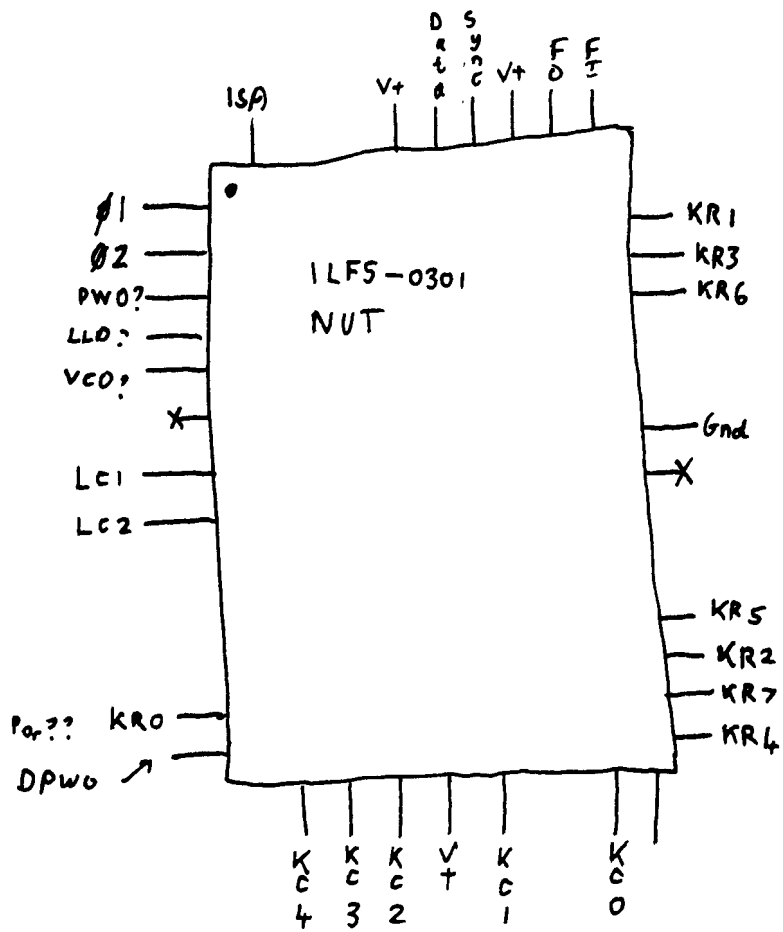
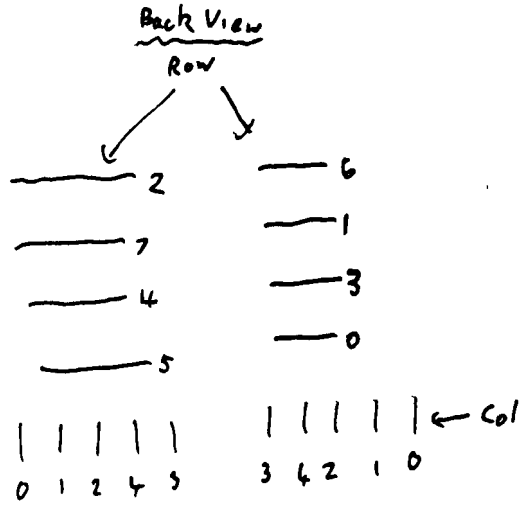

Voyager R202

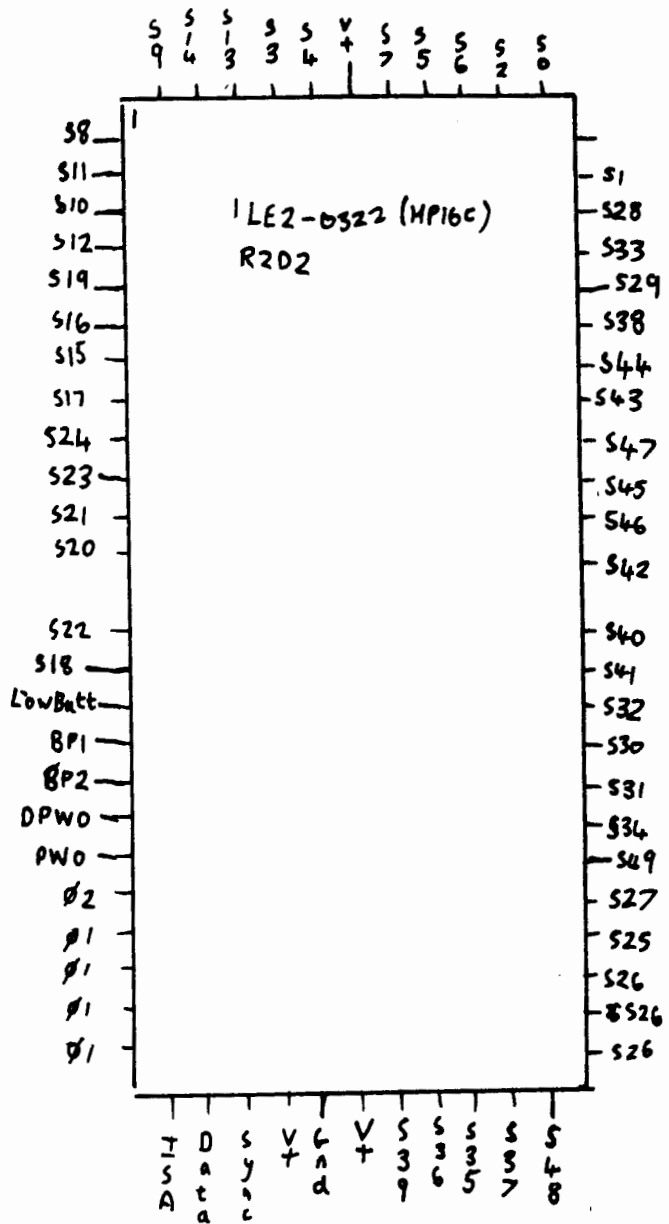

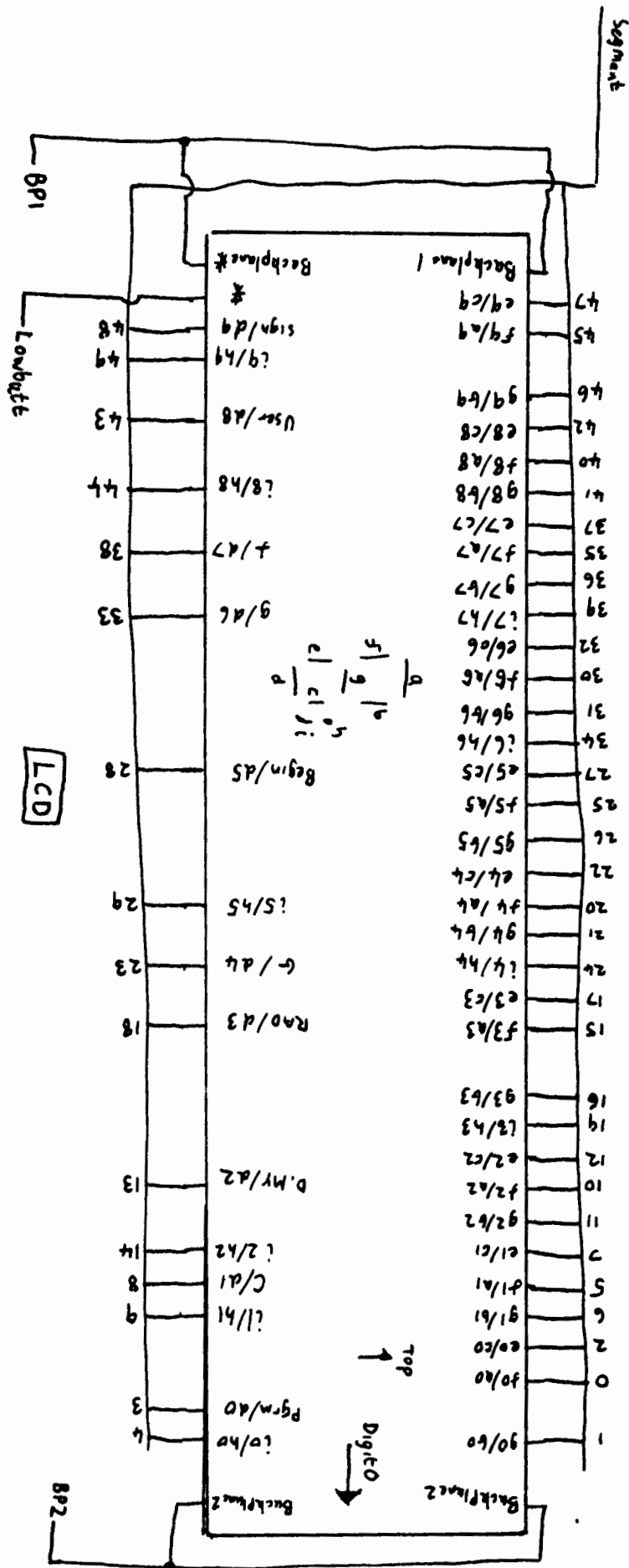

Voyager Logic Sheet 2

1130-0564

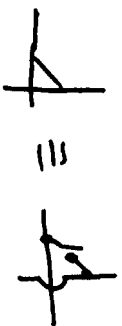
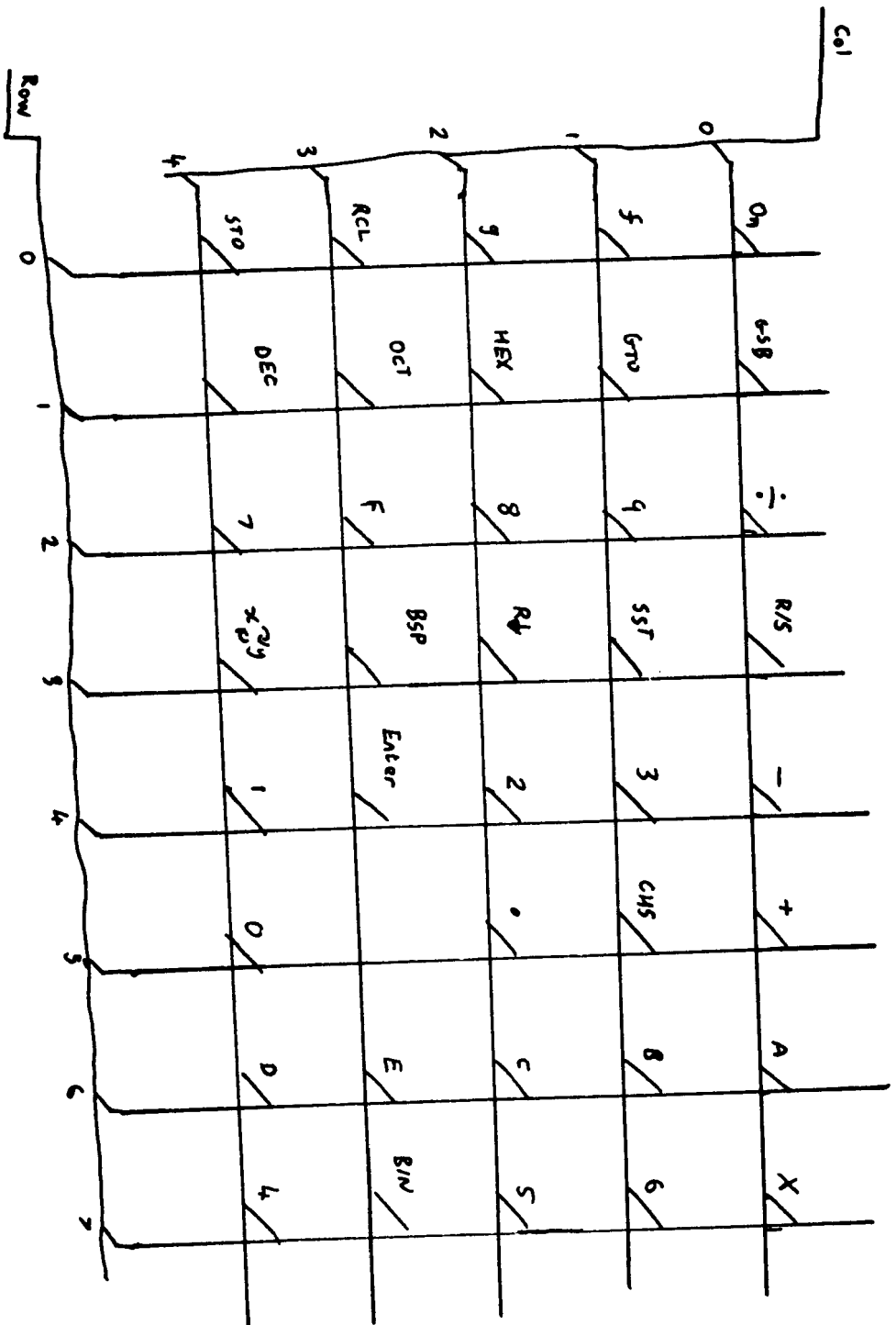
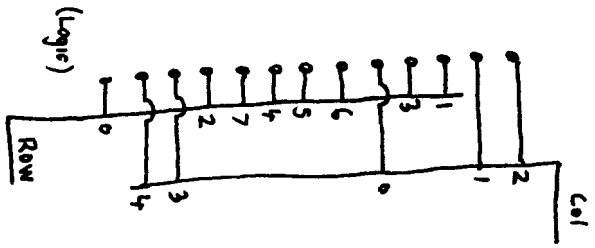

HP16c keyboard

00011-80002